

Dear partners and home owners,

Thankyou for your interest in an AGS Systems product, by THEINVISIBLETOOLBOX. In the following pages, you will find a compilation of all technical matters of relevance from the manufacturers of the Frame system.

Content:

- TCS50 - Extrusion - A dimensioned Section view _____ Page 2
- TCS50 - Technical Specifications _____ Page 3
- TCS50 - Installation instructions _____ Page 9
- TCS50 - Generic application details by AGS _____ Page 21

AGS solutions are of the highest technical credibility, and manufactured to excellent quality control standards.

The products are designed for easy installation, and a durable, beautiful result.

Installation details pertaining to any particular project may vary.

We encourage you to get in touch with us with any technical question: THEINVISIBLETOOLBOX will be happy to take your wall assembly specific requirements, and offer you a suitable CAD detail for an architectural application, where the relevant profile is detailed into your construction.

THEINVISIBLETOOLBOX, delivers technical support and sales services for the AGS product line in Canada. We are happy to be of service, to include sales support, guidance to tradesmen as well as take on complete door projects.

We look forward to hearing from you,
and taking part in your future opening challenges!
Best, THEINVISIBLETOOLBOX team.

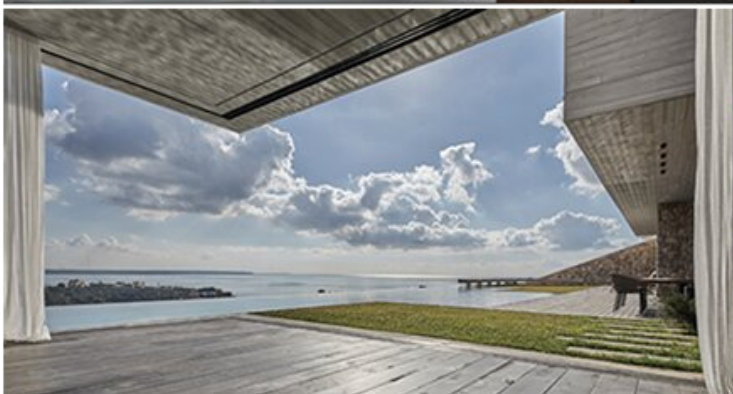

THEINVISIBLETOOLBOX

SOUND PRINCIPLES FOR MINIMAL CONSTRUCTION
By KOMETSEISE Inc. #36 Alberta Ave, Toronto Ontario. M6H-2R6
WWW.THEINVISIBLETOOLBOX.CA WWW.KOMETSEISE.COM
INFO@THEINVISIBLETOOLBOX.CA Phone: 647.500.4103



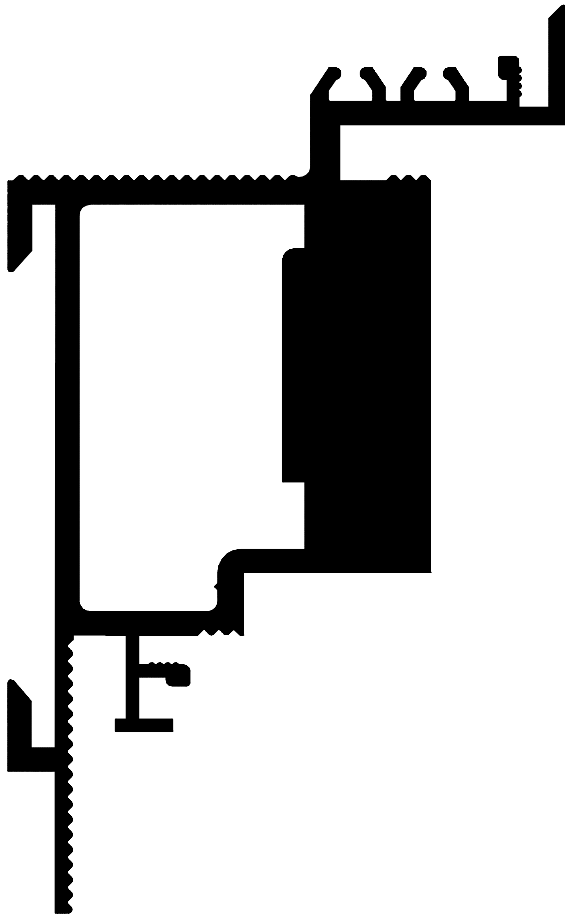
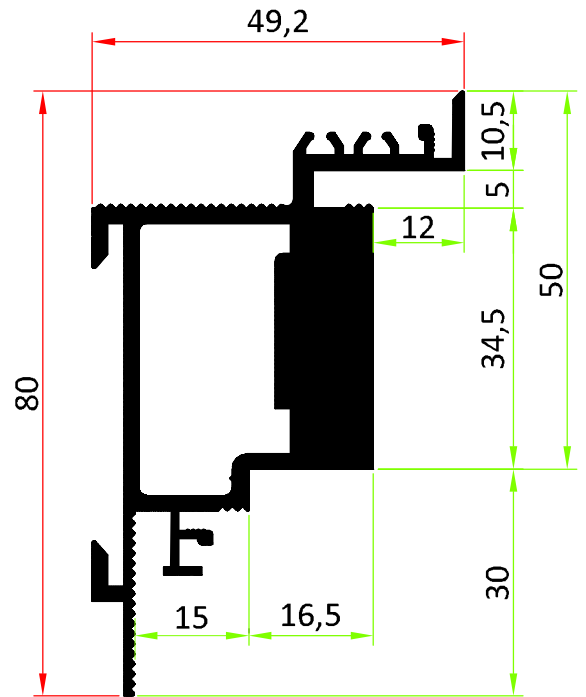

By
THEINVISIBLETOOLBOX.ca

SOUND PRINCIPLES FOR MINIMAL CONSTRUCTION
By KOMETSENSE Inc. #38 Alberta Ave, Toronto Ontario, M6H-2R6
WWW.THEINVISIBLETOOLBOX.CA WWW.KOMETSENSE.COM
INFO@THEINVISIBLETOOLBOX.CA Phone: 647.500.4103

AGS-Systems - 39025 Naturno (Italy)		
Drawing	TCS50 Art.nr. 10650	
Scala 1:1	Date	08 09 2014
	Modified	

Technical data sheet

**Model TCS50
 for inward opening doors**

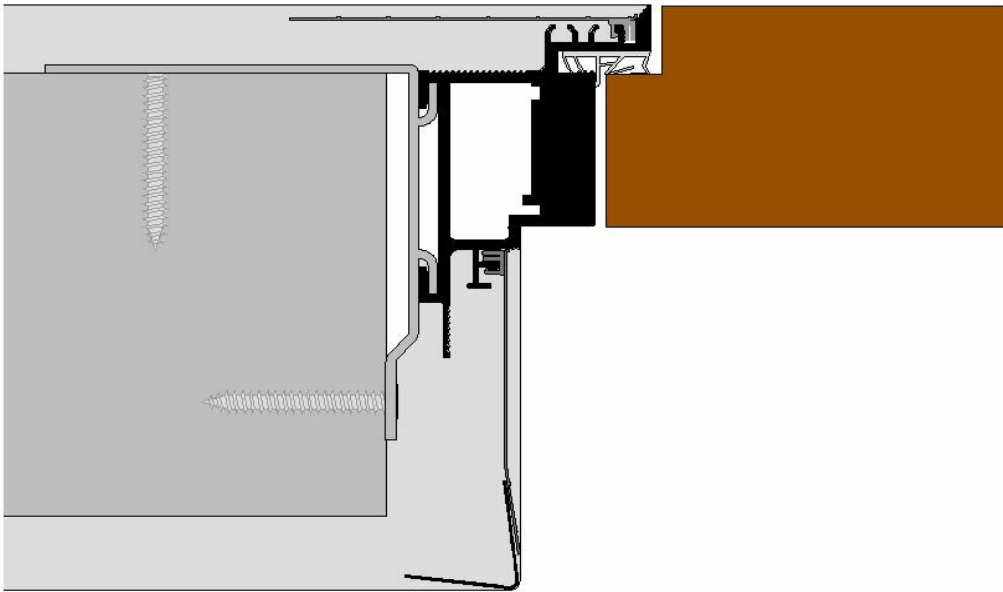

Frameless
 Flush
 Shadowgap
 Solutions



By
THEINVISIBLETOOLBOX.ca
SOUND PRINCIPLES FOR MINIMAL CONSTRUCTION
 By KOMETSENSE Inc. #98 Alberta Ave, Toronto Ontario, M6H-2R6
 WWW.THEINVISIBLETOOLBOX.CA WWW.KOMETSENSE.COM
 INFO@THEINVISIBLETOOLBOX.CA Phone: 647.500.4103

Index

Profile detail..... 2

Recommendations..... 3

 Suitable hinges..... 3

 Suitable closing panels..... 4

 Suitable electri-magnetic hold open door closers..... 4

 Suitable seals..... 5

Door leaf..... 6

Profile detail

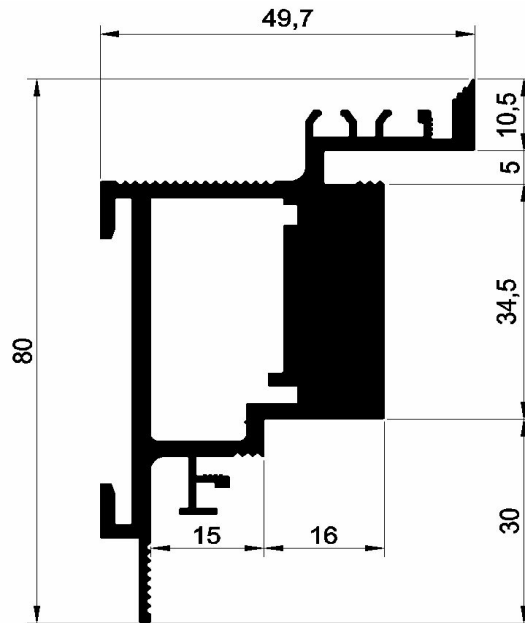

Model TCS50

Suitable for solid and dry construction

The frame profiles are supplied mitre-cut to suit door size, and machined to suit concealed hinges, lock strikes and other hardware. In combination with the snap-in corner connectors and the mounting brackets, this enables quick assembly and professional installation. The snap-in mesh ensures no plaster cracks between wall and frame. Suits standard or floor-to-ceiling doors.

Here you can find the assembling video:



masonry construction



drywal

Recommendations

On the basis of detailed tests and long-term experiences our technical office has prepared a recommendation list regarding the selection of hinges, closing panles and seals. This lists are practical guidelines and non exhaustive.

Suitable hinges	
<i>Description</i>	<i>Weight</i>
AGB Eclipse 3.0	40 kg
Anselmi 140 3D	40 kg
Anselmi 160 3D	60 kg
Anselmi 150 3D	40 kg
Anselmi 180 3D	80 kg
Basys Pivota DX42	60 kg
Basys Pivota DX43	60 kg
Basys Pivota DX60/DX100 Design	120kg
Basys Pivota DX60	100kg
Basys Pivota DX62	100kg
Basys Pivota DX38	40 kg
Ceam 1129	25/40 kg
Ceam 1130	40/60 kg
Krona Koblenz Kubica 2400	40 kg
Krona Koblenz Kubica 5080	45/60 kg
Krona Koblenz Kombi 3	40/52 kg
Krona Koblenz Kubica 6200	45/60 kg
Krona Koblenz Kubica 6400	30/45 kg
Krona Koblenz Kubica K7000	40/50 kg
Simonswerk Tectus TE 240 3-D	60 kg
Simonswerk Tectus TE 340 3-D	80 kg
SFS intec W-TEC 3D + 60	60 kg
Otlav IN 230 120	40/60 kg

Suitable closing panels	
<i>Name</i>	<i>Description striking plates</i>
Alban Giacomo SpA www.agb.it	AGB B01402.05.XX AGB B02402.28.XX AGB B01402.11.XX AGB B02402.09.XX AGB B02402.05.XX AGB B01.000.05.06
Basys Stabilo Schließbleche www.basyshome.com	Basys SBL 2-L just. V3 L - R Basys SBL 2-L just. V3 L – R 15mm Kante Basys SBL 2-L just. V3 L – R 13mm Kante Basys SBL 2-L just. V3 L – R 8mm Kante Basys B72-13 L – R Basys SBL Nr. 106 V3 Basys SBL Nr. 64 V3 Basys SBL Nr. 45 für Stangenschlösser Basys SBL Nr. 37 L - R
Bonaiti Serrature SpA www.bonaiti.it	Bonaiti G992 Noha Mini Bonaiti GI98 Bonaiti GR95 Bonaiti GIS8 Bonaiti GR/R/96 GR/R/97 Bonaiti B998 Bonaiti 996 Bonaiti GS91 Bonaiti G995
Kaba GmbH www.kaba.de	Kaba Cludo SB*/MAG/210.20.2,0/*/30 Kaba Cludo SB12/MAG/VAR/DS Kaba Cludo SB*MAG/120.20.2,0/* Kaba Cludo SB/MAG/VAR/NL mit Kante
KFV Karl Fliether GmbH & Co. Kg www.kfv.de	KFV 116-200-20HR/41 KFV 116-245-20HR/41 KFV 116-245-18HR/41 KFV 116-120-20HR/41 KFV 2600 K10

Suitable electric-magnetic hold open door closers	
<i>Producers</i>	<i>Item description</i>
Athmer www.athmer.de	Porti 5371
Dorma www.dorma.com	Dorma ITS96 N20 K8
Geze Boxer www.geze.com	Geze Boxer Gr. 2-4 with a sliding rail of 12mm

Suitable seals/gaskets	
<i>Producer</i>	<i>Item number</i>
Helmut Goll GmbH	A1020
Deventer Profile GmbH	S 6603 b
Deventer Profile GmbH	SP 7612
Primo Profile GmbH	ACF 5602 H
Schlegel GmbH	QL 3104
Schlegel GmbH	QL 3096

Door leaf

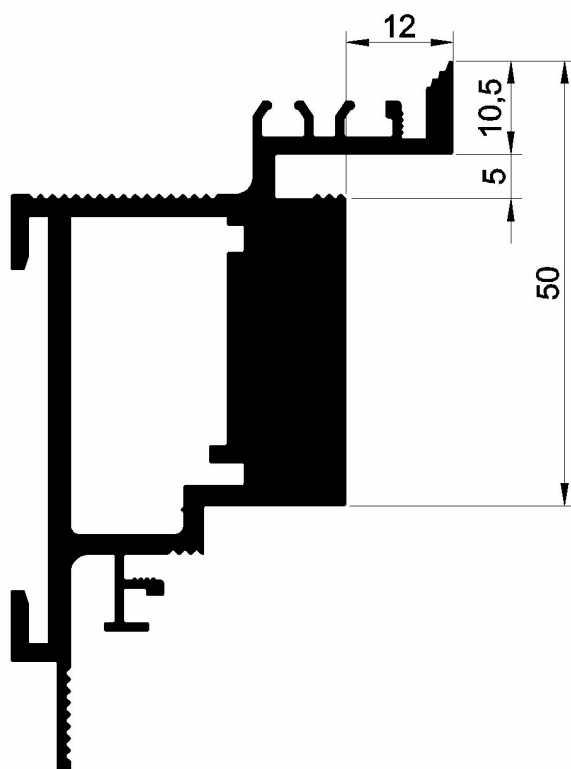

rebate dimension for 5mm door seal



We guarantee for a high quality of our products. Our processing guidelines are based on tests and practical experiences; they are only indication without assurance of properties, we have no influence on condition of construction sites and the realizations of the works

Country specific regulations, which consist on regional standards, building regulations, processing and industrial guidelines, can guide to specific processing recommendations.

FOR ANY TECHNICAL QUESTIONS
PLEASE CONTACT-

AGS Systems - Canada
By THEINVISIBLETOOLBOX
PH. 647.5004103
E. INFO@THEINVISIBLETOOLBOX.CA
WWW.THEINVISIBLETOOLBOX.CA
36 ALBERTA AVE. TORONTO
ONTARIO. M6H-2R6, CANADA.



By
THEINVISIBLETOOLBOX.ca

SOUND PRINCIPLES FOR MINIMAL CONSTRUCTION
By KOMETSENSE Inc. #36 Alberta Ave, Toronto Ontario, M6H-2R6
WWW.THEINVISIBLETOOLBOX.CA WWW.KOMETSENSE.COM
INFO@THEINVISIBLETOOLBOX.CA Phone: 647.500.4103

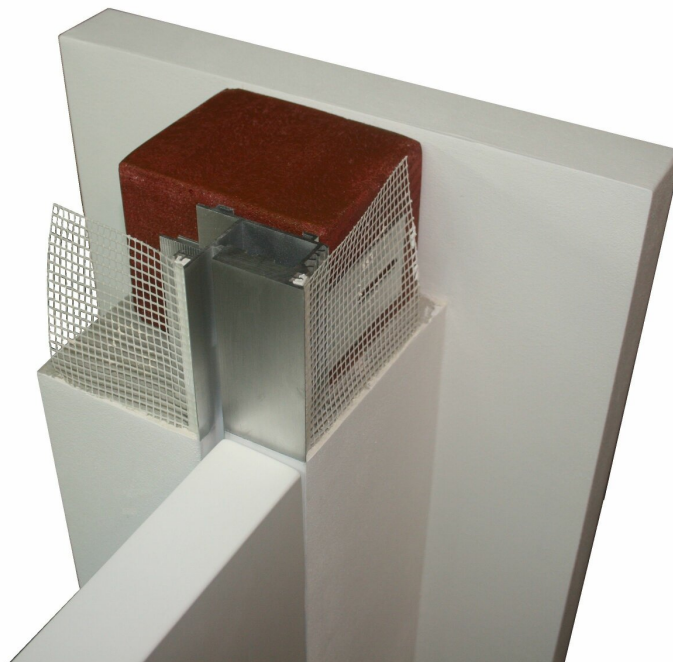

- DE Montageanleitung
- IT Istruzioni d'assemblaggio
- EN Assembly instructions
- FR Manuel d'assemblage

TCS/TCT



Bei den Modellreihen TCS/TCT handelt es sich um Aluminiumprofile zur Fertigung von FRAMELESS Türen für den Massiv- und Trockenbau. Je nach Türblatt kann die entsprechende Zarge in einer Stärke von 44/45 und 50 mm verbaut werden.

Die Aluminiumprofile werden auf Kundenwunsch angefertigt und, mit den entsprechenden Bohrungen für Scharniere und Schließblech, in Gehrung geschnitten angeliefert. Diese sind mit einer Schutzfolie versehen und werden im Set verpackt inkl. aller Montage- und Befestigungsteile angeliefert. Je nach Türblattstärke sind die Profile in verschiedenen Breiten erhältlich.

Die Türprofile bestehen aus einer rohen unbehandelten Aluminiumlegierung. Zement und seine Derivate produzieren, bei Nässe, alkalische Substanzen welche, wenn man diese auf der Oberfläche der Aluminiumlegierung arbeiten lässt, zu Korrosion führen kann. Deshalb wird empfohlen die Profile immer frei von Zement, Kleber und Fugenmaterial zu halten. Die Korrosion wird durch die empfohlene bauseitige Grundierung und Lackierung des Profils in Wandfarbe verhindert.



I modelli TCS/TCT sono profili d'alluminio per porte a filo muro del tipo FRAMELESS per strutture massicce e a secco. Secondo il modello scelto sono possibili ante da 44/45 oppure 50 mm.

Il telaio della porta viene prodotto secondo le esigenze del cliente come l'altezza, larghezza, spessore battente, numero delle cerniere, modello di cerniera e scontro per serratura. I profili sono muniti di una pellicola di protezione e vengono confezionati come kit, inclusi tutti gli accessori per un semplice e rapido montaggio.

I nostri profili porta consistono d'alluminio grezzo, non lavorato. L'alta umidità del cemento e dei suoi derivati producono sostanze alcaline che possono causare corrosioni. Per evitare questo consigliamo di tenere i profili sempre liberi di cemento, colle e altre sostanze corrosive. La corrosione può essere evitata anche verniciando i profili con delle apposite lacche. Tuttavia l'alluminio non è resistente a tutte le composte chimiche.



The aluminium profiles TCS/TCT are used to create FRAMELESS doors for solid and dry constructions. Depending on the door leaf a door frame with 44/45 and 50 mm can be used.

The TCS/TCT profiles are supplied mitre-cut to suit door size and milled to suit hidden hinges and striking panels or other hardware. All profiles are covered by a protective film and packed/delivered in a kit including the mounting- and fixing accessories.

The door profiles are made out of raw untreated aluminium. Cement and his derivatives produce alkaline substances when getting wet, which can provoke corrosion if they have time to work on the surface of the aluminium alloy. We recommend to keep the profiles clear from cement, glue and joints material. The above mentioned corrosion will be prevented by the recommended priming and finishing of the profiles in wall colours.



La gamme de modèles TCS/TCT sont constituées de profils en aluminium pour la fabrication de portes FRAMELESS (sans cadre) à utiliser en construction massive et sèche. Selon le vantail, le dormant correspondant peut être choisi dans une épaisseur de 44/45 et 50 mm.

Les profils en aluminium sont fabriqués sur demande du client et sont livrés, coupés en onglet, avec les perçages correspondants qui sont requis pour les charnières et les fermetures. Ils sont munis d'un film protecteur et sont livrés par lots, accompagnés de toutes les pièces de montage et de fixation. Selon l'épaisseur d'un vantail, les profils sont disponibles dans différentes largeurs.

En cas d'humidité, le ciment et ses dérivés produisent des substances alcalines susceptibles d'engendrer de la corrosion si on les laisse agir à la surface de l'alliage d'aluminium. C'est la raison pour laquelle il est recommandé de toujours veiller à ce que les profils soient exempts de ciment, d'adhésif et de matériau de joint. Le maître d'ouvrage peut empêcher la corrosion par l'application recommandée sur le profil d'une couche de fond et d'une couche de peinture dans la couleur des murs.

- DE 5 mm Sechskantschlüssel, zum verschrauben
- IT 5 mm brugola, da avvitare
- EN 5 mm hexagonal wrench, to screw
- FR 5 mm clé hexagonal, à visser

1

- DE Eckverbinder einschieben und Türzarge zusammensetzen (Detail A)
- IT Inserire gli angolari ed assemblare il telaio (dettaglio A)
- EN Insert the corner connector and assemble the door frame (detail A)
- FR Insérer les angles jusqu'à l'enclenchement et assemble les huisserie (détail A)

3

- DE Befestigungsbügel auf der Baustelle eindrehen (Detail C)
- IT Inserire le staffe di fissaggio (dettaglio C)
- EN Screw-in the wall fixing brackets at site (detail C)
- FR Tourner l'étrier de fixation sur le site (détail C)

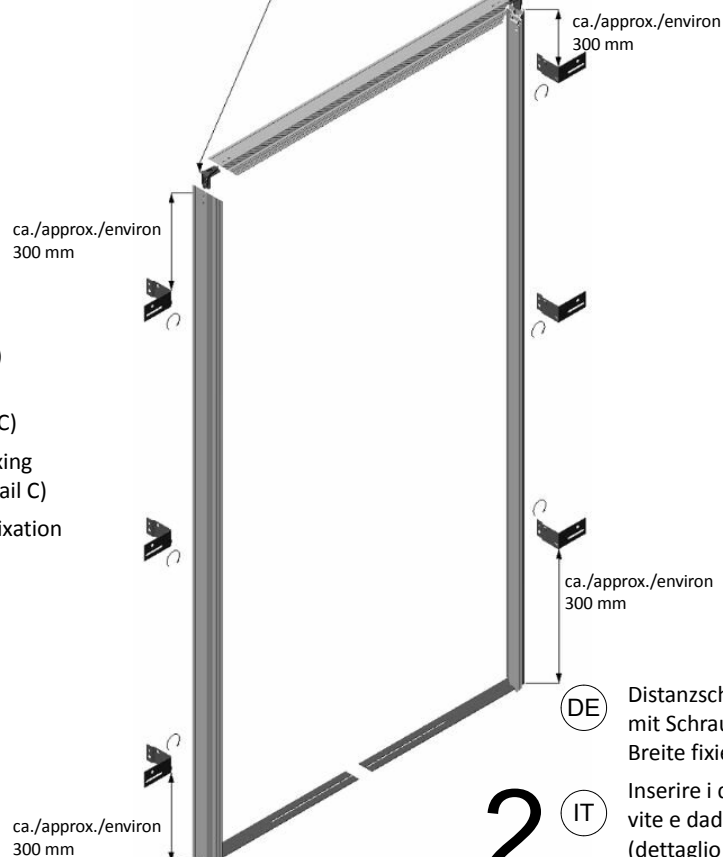

2

- DE Distanzschienen bis auf Anschlag einbringen und mit Schraube + Flügelmutter auf entsprechende Breite fixieren. Maximale Breite 1000 mm (Detail B)
- IT Inserire i distanziali fino alla battuta e fissarli con vite e dado ad alette alla larghezza adeguata (dettaglio B)
- EN Insert the bottom spreader bars to the limit top and fix it with screws + wing nut on the appropriate width. Maximum width 1000 mm (detail B)
- FR Insérer le rail d'écartement jusqu'à la butée et fixer à la largeur souhaitée à l'aide d'une vis + écrou papillon. Largeur maximale 1000 mm (détail B)

Detail/Dettaglio/Détail A

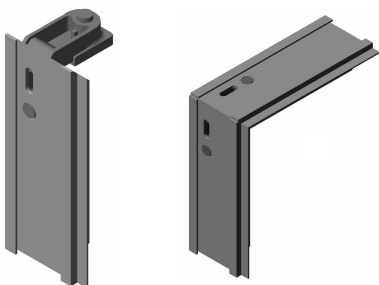

Detail/Dettaglio/Détail B

Distanzschienen/Distanziali/Bottom spreader bar/Barre d'écartement
Art. Nr./Item no. 13013

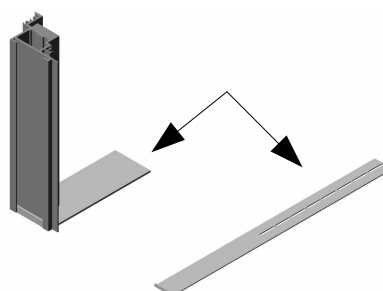

Detail/Dettaglio/Détail D

Mod. TCS45/TCS50

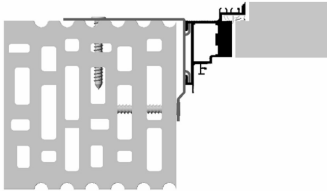

Mod. TCS50F

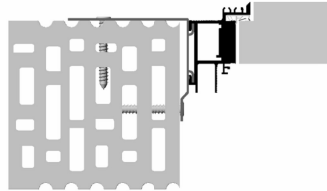

Mod. TCT

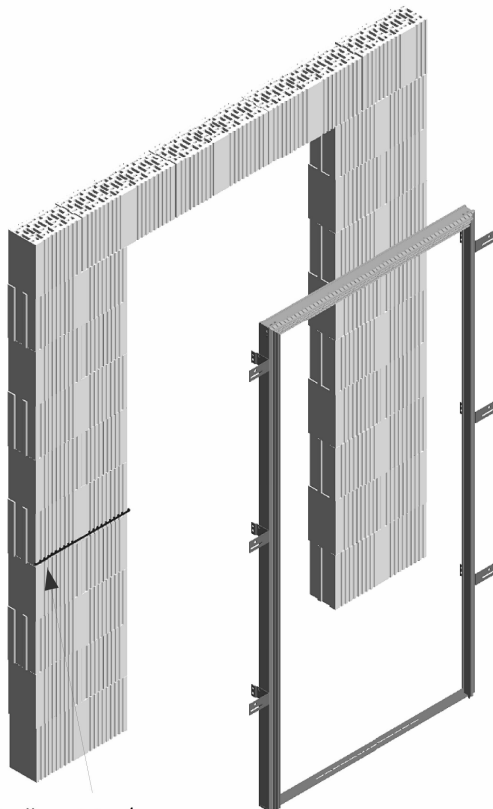
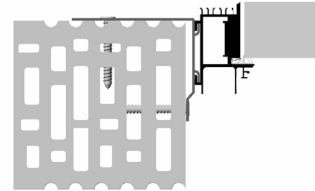

Meterriss/Livellometrico/
 Meter level/Trait de niveau

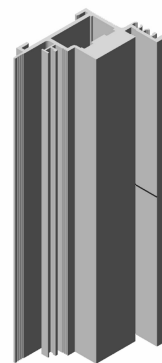

- DE Meterriss
- IT Livello metrico
- EN Meter level
- FR Trait de niveau

4

- DE Tüorzarge in die Maueröffnung einsetzen und auf Meterriss ausrichten (Detail D)
- IT Inserire il telaio nel foro muro e addattarlo al livello metrico (dettaglio D)
- EN Insert frame in the wall opening and set it up on the meter level (detail D)
- FR Insérer le châssis au jour de passage et le positionner sur le trait de niveau (détail D)

Detail/Dettaglio/Détail C

Befestigungswinkel/Staffe di fissaggio/Wall fixing brackets/Étrier de fixation
 Art. Nr./Item no. 13010a

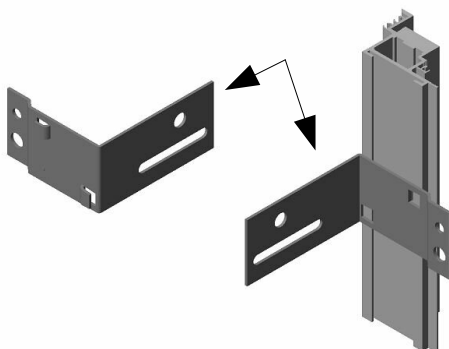

5

- DE Türlage horizontal und vertikal ausrichten und an allen Befestigungsbügeln verschrauben. Zuerst wandseitig befestigen danach leibungsseitig hinterfüllen und fixieren (Detail F)
- IT Regolare e spessorare il telaio a piombo ed avvitarlo alle staffe di fissaggio. (dettaglio F)
- EN Adjust the frame horizontally and vertically. Screw it together with the wall fixing brackets. At first install it at wall side and then fix and backfill it at the reveal side (detail F)
- FR Positionner le châssis horizontalement et verticalement. Fixer avec les étriers de fixation. D'abord l'installer du côté de mur et puis fixer et recouvre dans l'embrasure (détail F)

6

- DE Nach Befestigung die Zarge vollvolumig mit handelsüblichen PU-Montagekleber hinterfüllen
- IT Dopo il fissaggio riempire gli spazi rimanenti con una colla poliuretanica
- EN After fixation of the frame backfill it completely with a commercial PU-mounting adhesive
- FR Surmoussage le cadre avec une colle de montage PU commerciale après l'assemblage

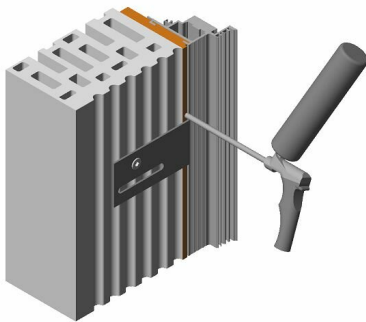

8

- DE Nach Befestigung und Hinterfüllung der Zarge die Distanzscheibe entfernen
- IT Rimuovere il distanziale dopo aver fissato e riempito gli spazi vuoti del telaio
- EN After fixing and backfilling of the frame remove the bottom spreader bar
- FR Retirer le rail d'écartement après l'assemblage et la soumoussage

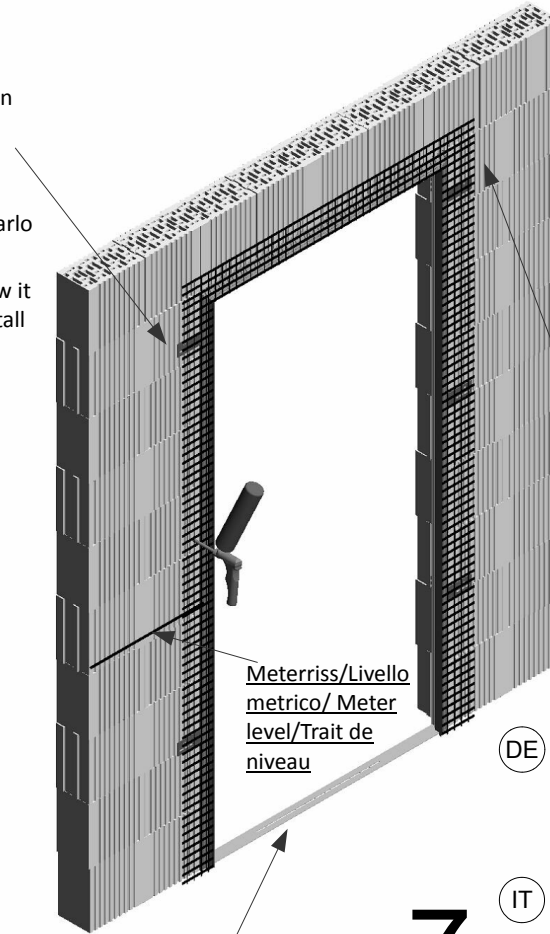

7

- DE Plastiksteg beim Putznetz oben an der Zargengehörung 10 cm entfernen, Putznetz einklicken (Detail G) und an den Ecken überlappen (Detail H)
- IT Rimuovere 10 cm del profilo di plastica della rete d'armatura ed incastrarla nel telaio. (dettaglio G) Sovrapporre la rete negli angoli (dettaglio H)
- EN Cut 10 cm of the plastic profile of the mesh at the mitre spot and click it in (detail G) and overlap the mesh on the angles (detail H)
- FR Détacher 10 cm de profil en plastique du filet support d'enduit et encliqueter (détail G) et veiller à ce que le filet se chevauche dans le coins (détail H)

Detail/Dettaglio/Détail F

Dübel/Tassello/Dowel/Cheville

Schrauben/Viti/Screws/Clés



Rahmenschrauben/Viti per telaio/Frame screws/Clés de cadre



Detail/Dettaglio/Détail G

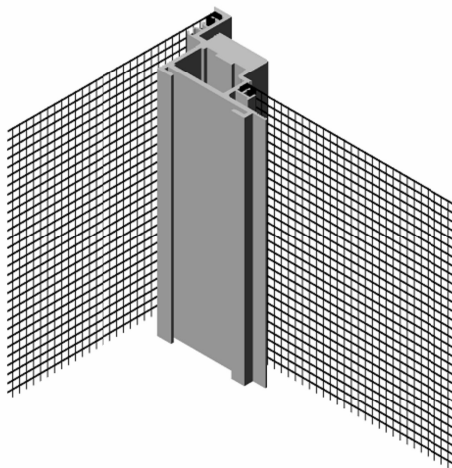

Mod. TCS

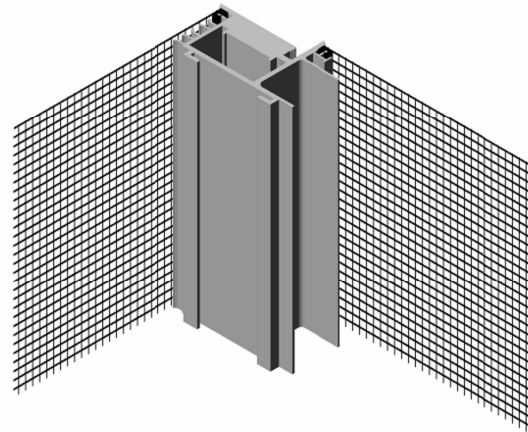

Mod. TCT

Detail/Dettaglio/Détail H

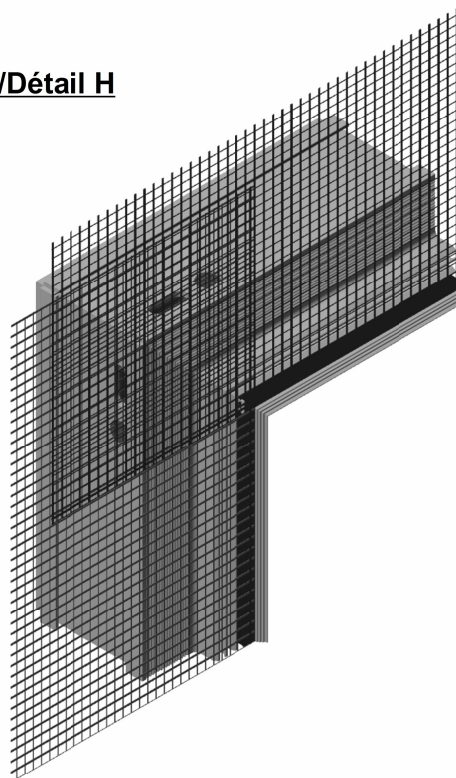

9

- DE Putznetz nach vorne klappen, Grundputz vollflächig auftragen und alle Hohlräume schließen
- IT Applicare l'intonaco su tutte le superficie senza lasciare camere d'aria dietro la rete d'armatura
- EN Fold the mesh forward, fully add the base plaster and close the cavities
- FR Basculer le filet an avant, recouverter entièrement d'enduit de fond et fermer les cavités

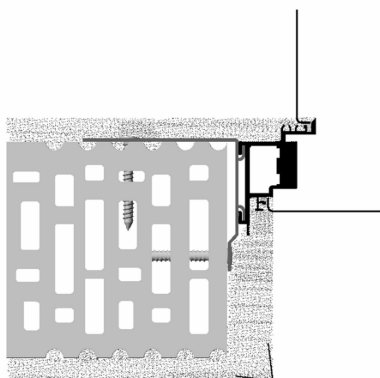

10

- DE Putznetz in Grundputz einbringen und einarbeiten
- IT Inserire la rete d'armatura nell'intonaco
- EN Insert and include the mesh to the base plaster
- FR Inserer et plâtrer le filet sur l'enduit de fond

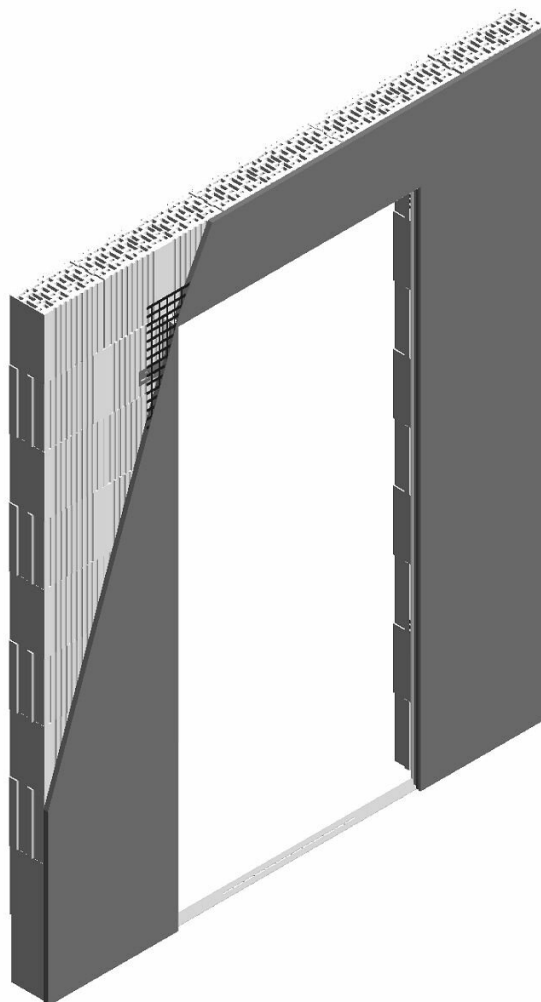
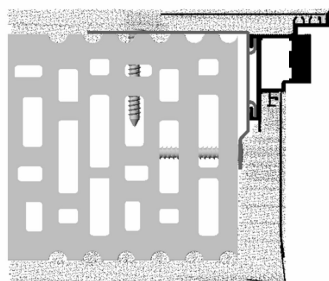

Mod. TCS45/TCS50

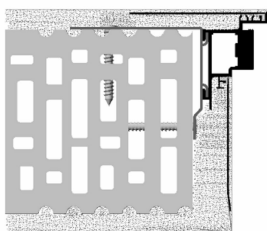

Mod. TCS50F

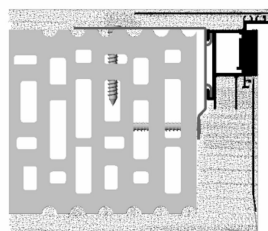

Mod. TCT

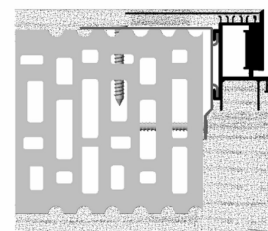

Detail/Dettaglio/Détail D

Mod. TCS45/TCS50

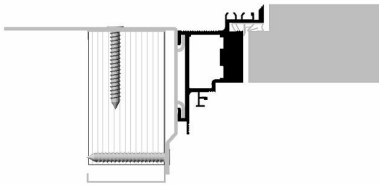

Mod. TCS50F

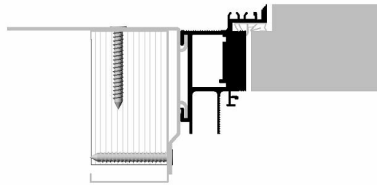

Mod. TCT

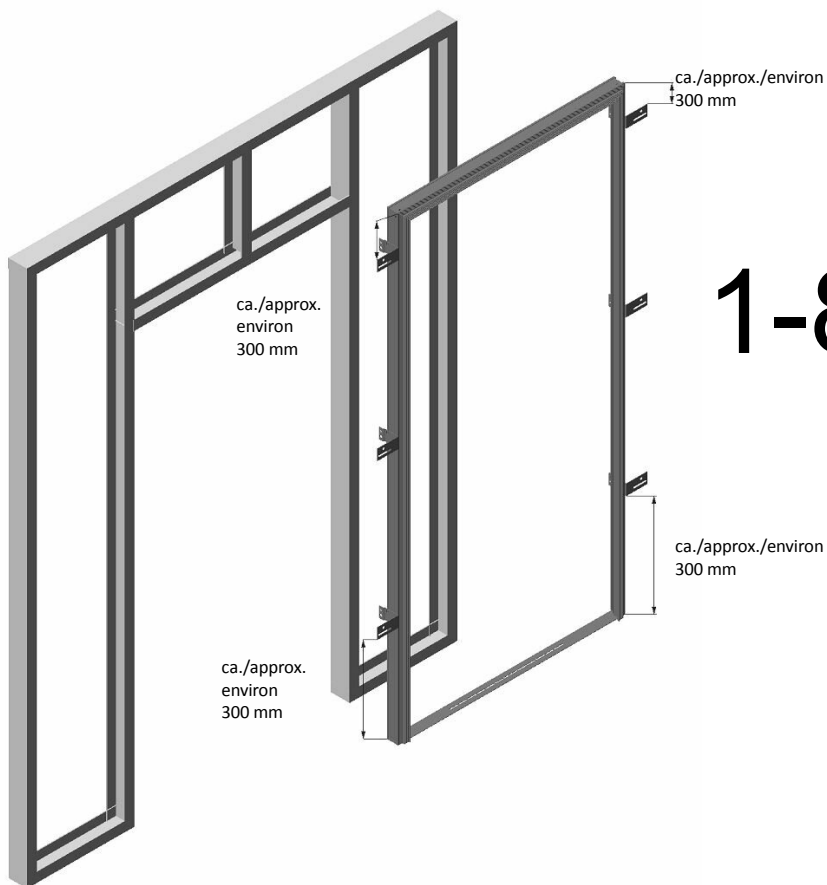
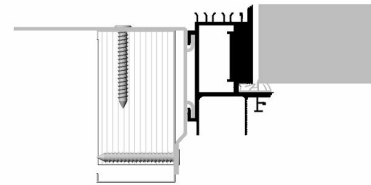

1-8

- Ⓛ DE Siehe Montage Mauerwerk
- Ⓛ IT Vedi montaggio su strutture massicce
- Ⓛ EN Like installation on solid construction
- Ⓛ FR Voir l'assemblage pour maçonnerie

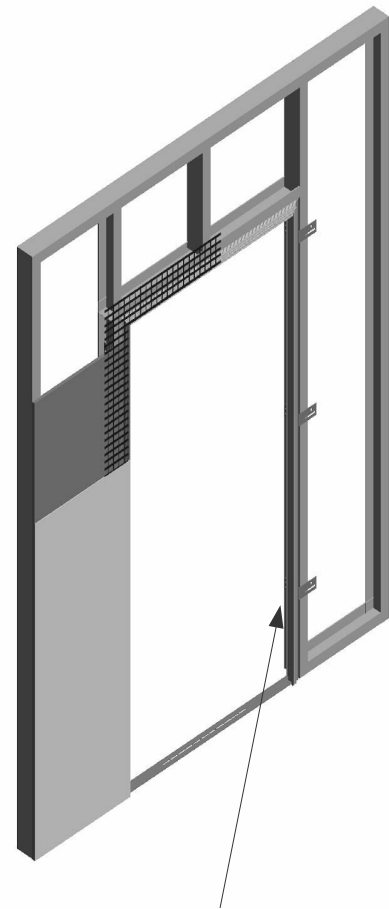
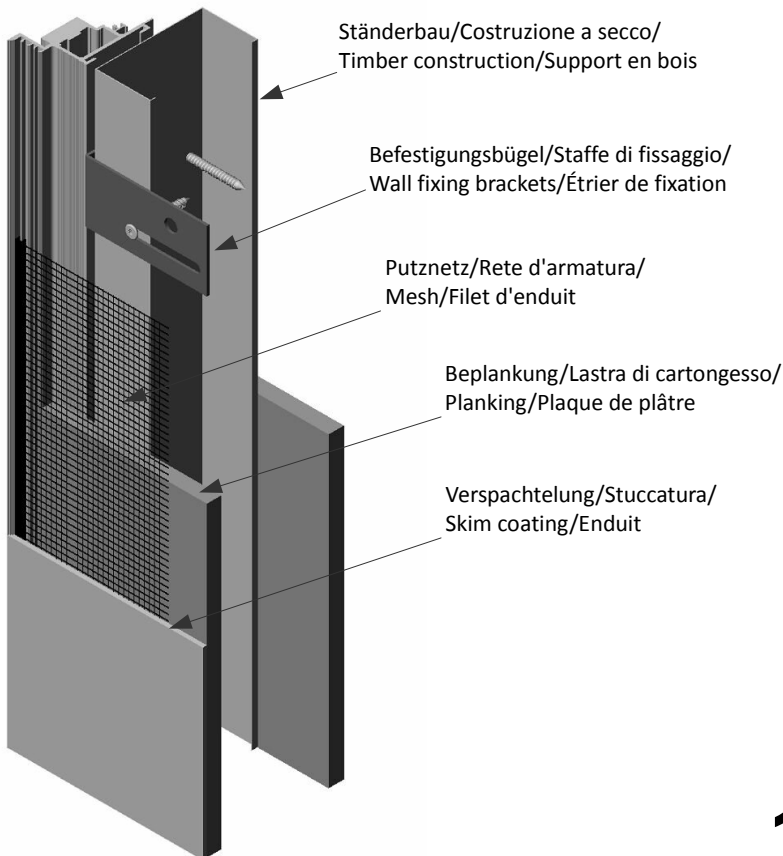

10

- DE Gipskartonplatten im Bereich der Befestigungsbügel ausnehmen um einen ebenen Anschluss zu gewährleisten (Detail K)
- IT Sventrare le lastre di cartongesso sulla posizione delle staffe di fissaggio per garantire una superficie adeguata (dettaglio K)
- EN To guarantee a flush connection cut off the gypsum boards where the wall fixing brackets have been installed (detail K)
- FR Pour garantir la connexion à fleur couper la plaque de plâtre où les étrier de fixation ont été installés (détail K)

Detail/Dettaglio/Détail K

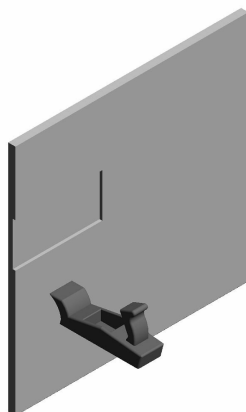

- DE Gipsplatten im Bereich der Befestigungsbügel ausnehmen, z.B. mit einem Gipshobel
- IT Sventrare le lastre di cartongesso sulla posizione delle lastre di fissaggio, p.e. usando una pialla
- EN Work off the gypsum board where the wall fixing brackets have been installed, f.e. by using a plane
- FR Couper la plaque de plâtre où les étrier de fixation ont été installés, p.e. avec un rabot

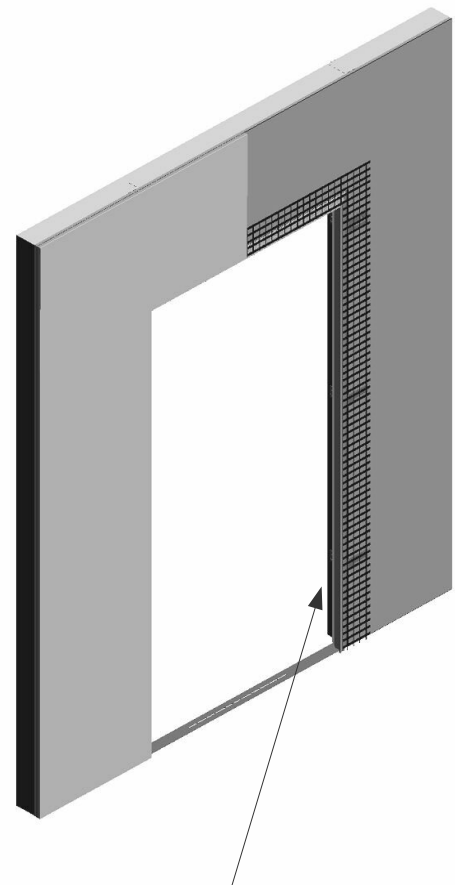
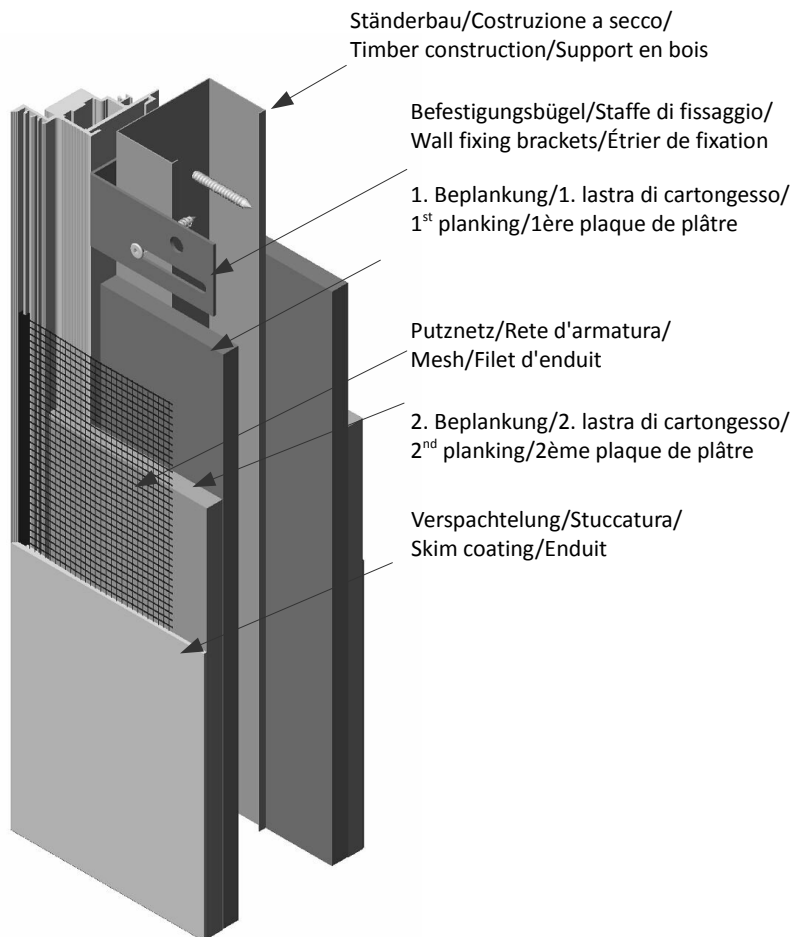

Detail/Dettaglio/Détail K

Mod. TCS45/TCS50

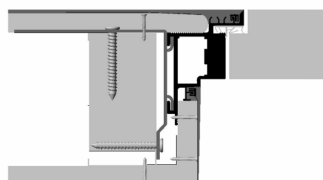

Mod. TCS50F

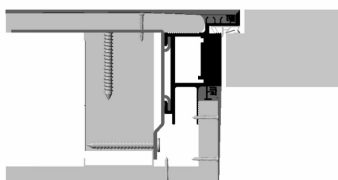

Mod. TCT

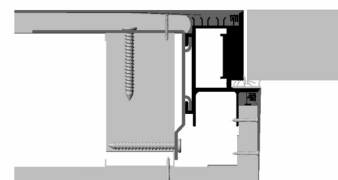

- DE Einfachbeplankung
- IT Singola lastra
- EN Single layer
- FR Single plaque de plâtre

- DE Einfachbeplankung
- IT Singola lastra
- EN Single layer
- FR Single plaque de plâtre

- DE Einfachbeplankung
- IT Singola lastra
- EN Single layer
- FR Single plaque de plâtre

Mod. TCS45/TCS50

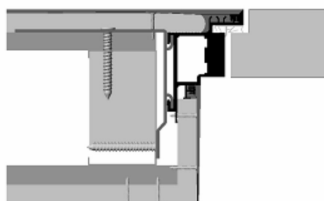

Mod. TCS50F

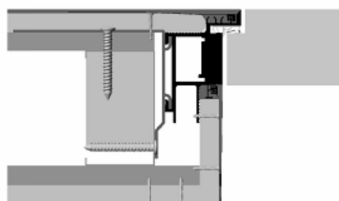

Mod. TCT

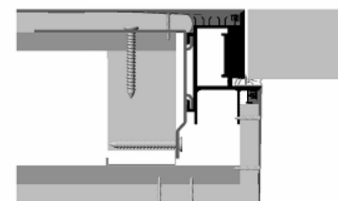

- DE Doppelbeplankung
- IT Doppia lastra
- EN Double layer
- FR Double plaque de plâtre

- DE Doppelbeplankung
- IT Doppia lastra
- EN Double layer
- FR Double plaque de plâtre

- DE Doppelbeplankung
- IT Doppia lastra
- EN Double layer
- FR Double plaque de plâtre

.....

.....

.....

.....

.....

.....

.....

.....

.....

.....

.....

.....

.....

.....

.....

.....

.....

.....

.....

.....

.....

.....

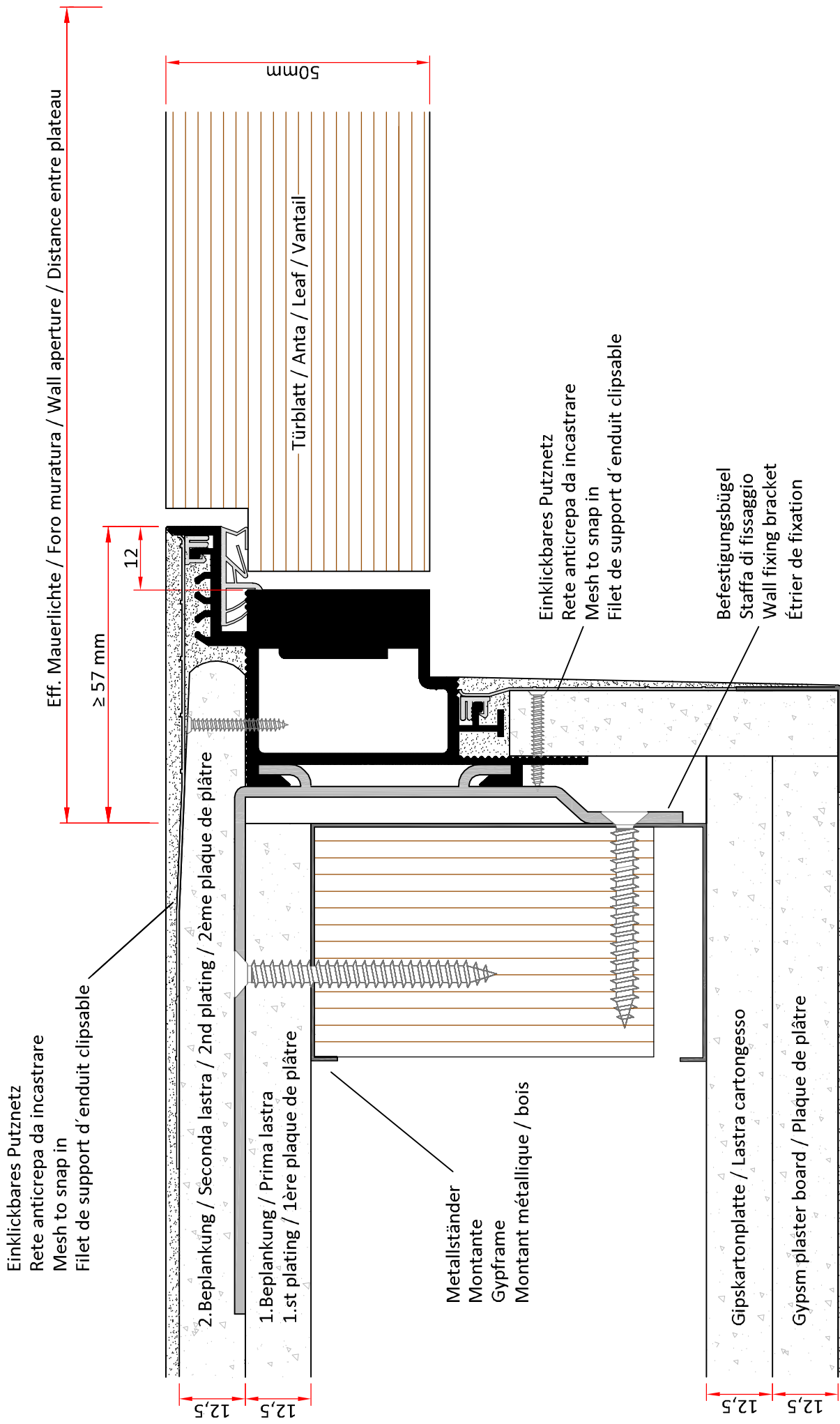

FOR ANY TECHNICAL QUESTIONS PLEASE CONTACT US. WE ARE ABLE TO OFFER CAD FILES OF APPLICATION DRAWINGS PER ANY RELEVANT WALL ASSEMBLY. THANKYOU!

AGS Systems - Canada. By THE INVISIBLE TOOLBOX
PH. 647.5004103 | E. INFO@THEINVISIBLETOOLBOX.CA WWW.THEINVISIBLETOOLBOX.CA
36 ALBERTA AVE. TORONTO ONTARIO. M6H-2R6, CANADA.

AGS-Systems - 39025 Naturno (Italy)	
Drawing	TCS50 Art.nr. 10650
Scala 1:1	Date 09 01 2015
	Modified
AGS-systems - 39025 Naturno (Italy) Stava 47B tel. 0039 0473 666376 - info@ags-systems.com	

This drawing is copyright by AGS-systems and exclusive, protected by law and cannot reproduced without written affirmation

Einklickbares Putznetz
 Rete anticrepa da incastrare
 Mesh to snap in
 Filet de support d'enduit clipsable

Eff. Mauerlichte / Foro muratura / Wall aperture / Distance entre plateau

≥ 57 mm

12

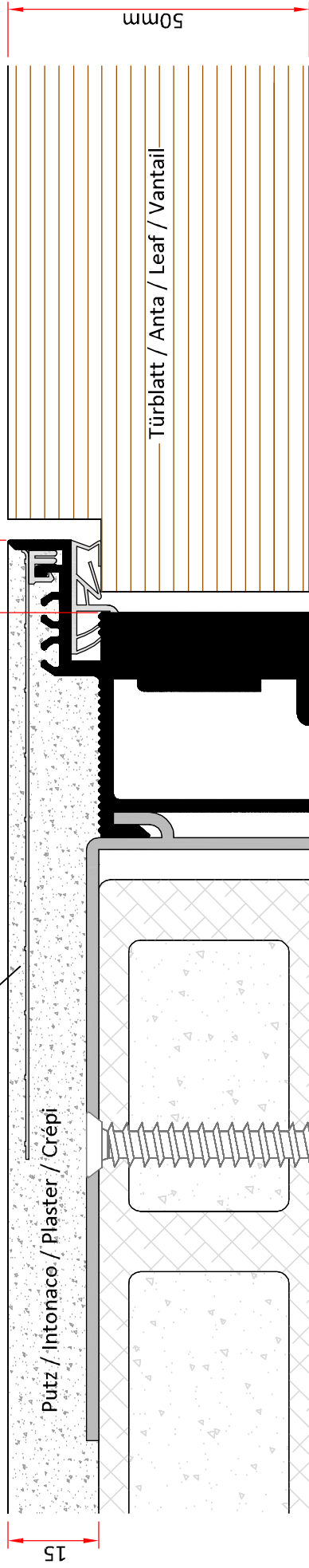

Putz / Intonaco / Plaster / Crépi

Mauerwerk
 Muratura grezza
 Masonry
 Maçonnerie

Putz / Intonaco / Plaster / Crépi

50mm

Türblatt / Anta / Leaf / Vantail

Einklickbares Putznetz
 Rete anticrepa da incastrare
 Mesh to snap in
 Filet de support d'enduit clipsable

Befestigungsbügel
 Staffa di fissaggio
 Wall fixing bracket
 Étrier de fixation

FOR ANY TECHNICAL QUESTIONS PLEASE CONTACT US. WE ARE ABLE TO OFFER CAD FILES OF APPLICATION DRAWINGS PER ANY RELEVANT WALL ASSEMBLY. THANKYOU!

AGS Systems - Canada. By THE INVISIBLE TOOLBOX
 PH. 647.5004103 | E. INFO@THEINVISIBLETOOLBOX.CA WWW.THEINVISIBLETOOLBOX.CA
 36 ALBERTA AVE. TORONTO ONTARIO. M6H-2R6, CANADA.

AGS-Systems - 39025 Naturno (Italy)

Drawing TCS50 Art.nr. 10650

Scala 1:1 Date 09 01 2015

Modified

AGS-systems - 39025 Naturno (Italy) Stava 47B
 tel. 0039 0473 666376 - info@ags-systems.com

This drawing is copyright by AGS-systems and exclusive, protected by law and cannot reproduced without written affirmation

Thanks for your interest, and please keep in touch!

THEINVISIBLETOOLBOX.

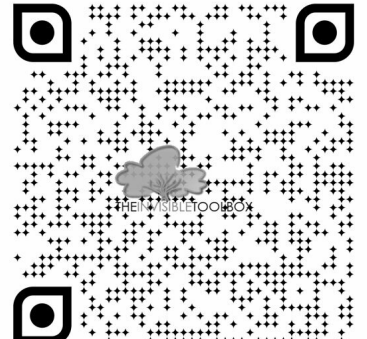
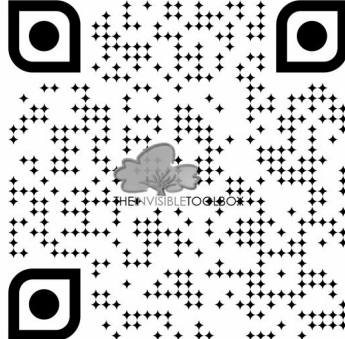
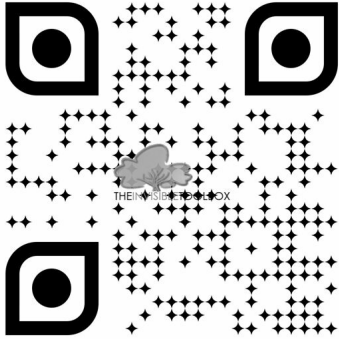

Frameless
Flush
Shadowgap
Solutions

IAGS systems

By
THEINVISIBLETOOLBOX.ca

SOUND PRINCIPLES FOR MINIMAL CONSTRUCTION
By KOMETSENSE Inc. #36 Alberta Ave, Toronto Ontario. M6H-2R6
WWW.THEINVISIBLETOOLBOX.CA WWW.KOMETSENSE.COM
INFO@THEINVISIBLETOOLBOX.CA Phone: 647.500.4103

